

CARRELLI E BANCHI DA LAVORO

TROLLEYS AND WORKBENCHES
CHARIOTS ET ETABLIS DE TRAVAIL
WAGEN UND WERKBÄNKE

Made in Italy 







ART. 109/A



*ART. 109/AS

ART. 109/A • 109/AS
CARRELLO PORTA ATTREZZI

Tool carrying trolley
Chariot porte-outils
Werkzeugwagen

| | | | | | |
|----------------|---|---|---|---|---|
| ART. |  |  |  |  |  |
| 109/A • 109/AS | 120 kg | 700 mm | 750 mm | 350 mm | 60 mm |

*Smontabile • demountable • demontables • zerlegbar







ART. 109/B



*ART. 109/BS

ART. 109/B • 109/BS
CARRELLO PORTA ATTREZZI TIPO PESANTE

Heavy tool carrying trolley
Chariot porte-outils, lourd
Werkzeugwagen stabile Ausführung

| | | | | | |
|----------------|---|---|---|---|---|
| ART. |  |  |  |  |  |
| 109/B • 109/BS | 150 kg | 800 mm | 750 mm | 420 mm | 80 mm |

*Smontabile • demountable • demontables • zerlegbar







ART. 109/C



*ART. 109/CS

ART. 109/C • 109/CS
CARRELLO PORTA ATTREZZI TIPO PESANTE, CON CASSETTO

Heavy tool carrying trolley with drawer
Chariot porte-outils, lourd avec tiroir
Werkzeugwagen stabile Ausführung mit abschließbarer Schublade

| | | | | | |
|----------------|---|---|---|---|---|
| ART. |  |  |  |  |  |
| 109/C • 109/CS | 150 kg | 800 mm | 750 mm | 420 mm | 80 mm |

*Smontabile • demountable • demontables • zerlegbar



ART. 208



*ART. 208/S

ART. 208 • 208/S
CARRELLO GIGANTE A TRE PIANI

Three-shelf giant trolley
Chariot geant à trois etages
Tischwagen mit drei flächen stabile ausführung

| | | | | | |
|-------------|---|---|---|---|---|
| ART. |  |  |  |  |  |
| 208 • 208/S | 180 kg | 1000 | 830 | 600 | 125 |

*Smontabile • demountable • demontables • zerlegbar



ART. 209



*ART. 209/S

ART. 209 • 209/S
CARRELLO GIGANTE A TRE PIANI, CON CASSETTO

Three-shelf giant trolley with drawer
Chariot geant à trois etages et tiroir
Tischwagen mit drei Flächen und einer abschliessbaren Schublade

| | | | | | |
|-------------|---|---|---|---|---|
| ART. |  |  |  |  |  |
| 209 • 209/S | 180 kg | 1000 | 830 | 600 | 125 |

*Smontabile • demountable • demontables • zerlegbar







ART. 211



*ART. 211/A

ART. 211 • 211/A
CARRELLO CON SPONDE E RETE METALLICA PERIMETRALE

Sideboarded trolley with external wire net
Chariot a bords hauts grillagés
Metallgitterwagen

| | | | | | |
|-------|---|---|---|---|---|
| ART. |  |  |  |  |  |
| 211 | 250 kg | 1000 | 850 | 600 | 125 |
| 211/A | 250 kg | 1020 | 950 | 600 | 125 |

*Smontabile • demountable • demontables • zerlegbar

ART. 207
CARRELLO CON SPONDA

Sideboarded trolley
Chariot avec dossier
Wagen mit Stützwand







ART. 207

ART. 210
CARRELLO CHIUSO PORTA ATTREZZI A QUATTRO PIANI CON SERRATURA

Four-shelf closed tool carrying trolley with lock
Chariot porte-outils a quatre etages avec termeture
Fahrbarer, abschliessbarer Werkzeugschrank mit Griff



ART. 210

| ART. |  |  |  |  |  |
|------------|---|---|---|---|---|
| | | mm | mm | mm | mm |
| 207 | 250 kg | 1000 | 900 | 600 | 125 |
| 210 | 200 kg | 800 | 900 | 450 | 100 |

ART. 099
SDRAIO

Cradle
Chariot de visite
Rollbrett



ART. 099/B
SDRAIO CON STRUTTURA IN TUBOLARE E SCHIENALE COMPLETAMENTE IMBOTTITO

Cradle with tubular structure and completely stuffed back
Chariot de visite, à structure tubulaire et dossier entièrement rembourré
Liegeschlitten mit rohrförmigem Rahmen, vollständig gepolstert





| ART. |  |  |  |
|--------------|---|---|---|
| | | mm | mm |
| 099 | 150 kg | 1000 | 440 |
| 099/B | 150 Kg | 1000 | 440 |

CE Made in Italy 

ART. 092 CARRELLO MILLEUSI

Several uses trolley
Chariot multi-usages
Sackkarre

ART.  
092 | 300 kg | 200

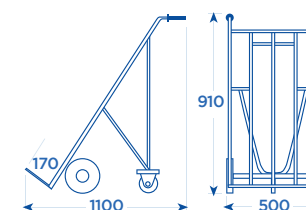

ART. 095 CARRELLO PORTA BOMBOLE

Cylinder holder trolley
Chariot porte-bonbonnes
Gasflaschenwagen

ART.  
095 | 200 kg | 250

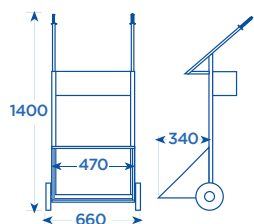

ART. 095/A CARRELLO PORTA BOMBOLA

Cylinder holder trolley
Chariot porte-bonbonne
Gasflaschenwagen

ART.  
095/A | 200 kg | 250

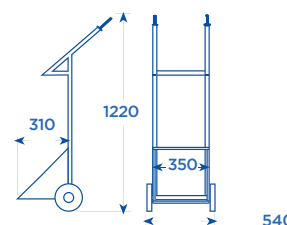

ART. 213
CARRELLO
PORTA CASSE

Case carrying trolley
Chariot porte-caisses
Sackkarre

ART.  
213 | 200 kg | 200

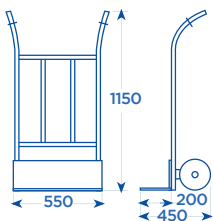

Tipo pesante • Heavy-type • Type-lourd • Schwere ausführung

ART. 214
CARRELLO
PORTA CASSE

Case carrying trolley
Chariot porte-caisses
Sackkarre

ART.  
214 | 100 kg | 200

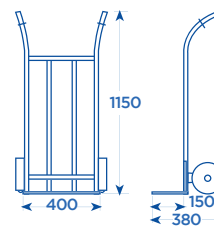

Tipo leggero • Light-type • Type-leger • Leichte ausführung

ART. 214/A
CARRELLO MULTIUSO
PER TRASPORTO SU SCALE

Multipurpose trolley for transport on stairs
Chariot multi-usages pour transport sur escalier
Multifunktions-Sackkarre, speziell geeignet für Treppen

ART.  
214/A | 250 kg | 150

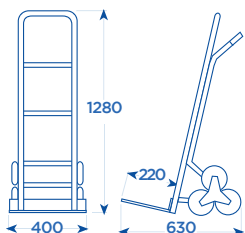

ART. 214/B
CARRELLO PORTA
CASSE STRETTO

Case carrying trolley tight
Chariot porte-caisses étroit
Enge Sackkarre

ART.  
214/B | 250 kg | 260

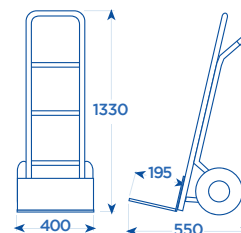

Tipo pesante • Heavy-type • Type-lourd • Schwere ausführung

BANCHI DA LAVORO

Workbenches
Etablis de travail
Werkbänke

CE Made in Italy 



ART. 1000



ART. 1002



ART. 1004







ART. 1000/PL



ART. 1002/PL



ART. 1004/PL

| ART. |  | Pianale in legno Wooden-top Plan de travail en bois Holzoberfläche | Numero di cassetti Number of drawers Nombre de tiroirs Anzahl der Schubladen |  |  |  |
|---------|---|---|---|---|--|---|
| | | | | mm | mm | mm |
| 1000 | 700 kg | | 1 | 1000 | 850 | 700 |
| 1000/PL | 700 kg | ✓ | 1 | 1000 | 880 | 700 |
| 1001 | 600 kg | | 1 | 1500 | 850 | 700 |
| 1001/PL | 600 kg | ✓ | 1 | 1500 | 880 | 700 |
| 1002 | 600 kg | | 2 | 1500 | 850 | 700 |
| 1002/PL | 600 kg | ✓ | 2 | 1500 | 880 | 700 |
| 1003 | 400 kg | | 2 | 2000 | 850 | 700 |
| 1003/PL | 400 kg | ✓ | 2 | 2000 | 880 | 700 |
| 1004 | 400 kg | | 3 | 2000 | 850 | 700 |
| 1004/PL | 400 kg | ✓ | 3 | 2000 | 880 | 700 |

Vengono forniti in versione smontabile per una più facile e razionale gestione del trasporto e dell'immagazzinaggio. Possono essere forniti con pianale in lamiera o con pianale in legno. Tutti i cassetti sono dotati di serratura e lo scorrimento avviene su guide con cuscinetto. Verniciatura a polvere epossidica.

They are supplied in dismantlable version for an easier and more rational transport and storage. They can be supplied complete with steel-top or complete with wooden-top. All drawers are equipped with lock and their sliding is on bearing-guides. Epoxy-powdered painting.

Livrés en version démontable pour faciliter transport et stockage. Livrés avec plan de travail en tôle ou avec plan de travail en bois. Tiroirs sur glissières et équipés de serrure. Peinture epoxy.

Die Werkbänke werden in zerlegtem Zustand geliefert. Die Oberfläche ist in Holz-oder Stahl-Ausführung. Alle Schubladen sind abschließbar und kugelgelagert. Die Oberfläche ist epoxidpulverbeschichtet.

ACCESSORI

ACCESSORIES
ACCESSOIRES
ZUBEHÖR





ART. 1052

PANNELLI

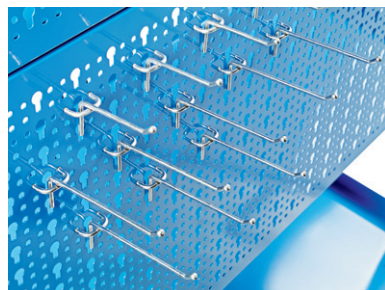
Panels • Panneaux • Paneele



| ART. |  |  |  |
|------|---|---|---|
| | | mm | mm |
| 1050 | | 940 | 440 |
| 1051 | | 975 | 975 |
| 1052 | ✓ | 975 | 870 |
| 1053 | ✓ | 1445 | 870 |

CASSETTI

Drawer units • Caisson-Tiroirs
Schubkastenelemente



ART. 1011

| | | |
|---|---|---|
|  |  |  |
| mm | mm | mm |
| 130 | 530 | 400 |

GANCI

Hooks • Crochets • Haken

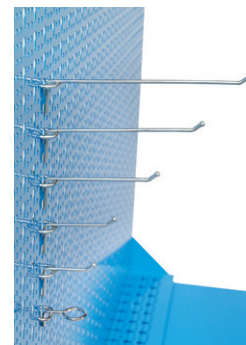

ART. 1070
200 mm

ART. 1071
150 mm

ART. 1072
120 mm

ART. 1073
80 mm

ART. 1074
60 mm

ART. 1075
con occhiello
with eyelet
avec oeillet
mit Öse

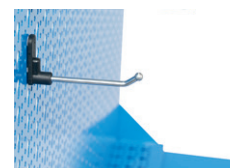

ART. 1077
100 mm

ART. C51/A
CARRELLO A QUATTRO RIPIANI, COMPLETO
DI DOPPIO PANNELLO PORTAUTENSILI

Four-level-trolley, complete with double tool-holding panel
 Chariot à quatre étages avec deux panneaux porte-outils
 Wagen mit 4 Ablageflächen und 2 Werkzeug-Lochaufnahmeplatten

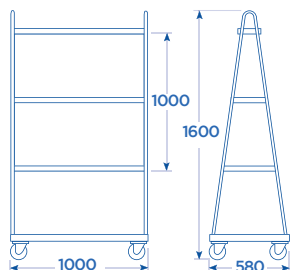

ART. C52
CARRELLO A DUE RIPIANI, COMPLETO
DI PANNELLO PORTAUTENSILI

Two-level-trolley, equipped with tool-holding panel
 Chariot à deux étages avec panneau porte-outils
 Wagen mit 2 Ablageflächen und einer zweiseitigen
 Werkzeug-Lochaufnahmeplatte

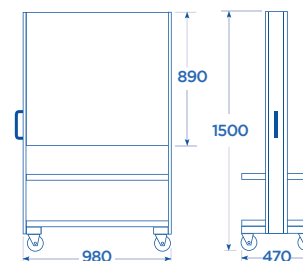

ART. C53 • C54 • C55
PANNELLI PORTA UTENSILI
COMPOSTI DA PANNELLI BIFACCIALI

Tool-holding panels equipped with byfacial panels
 Panneaux porte-outils. Équipés de panneaux double face

Werkzeug-Lochaufnahmeplatten mit doppelseitigen
 Werkzeug-Lochaufnahmeplatten

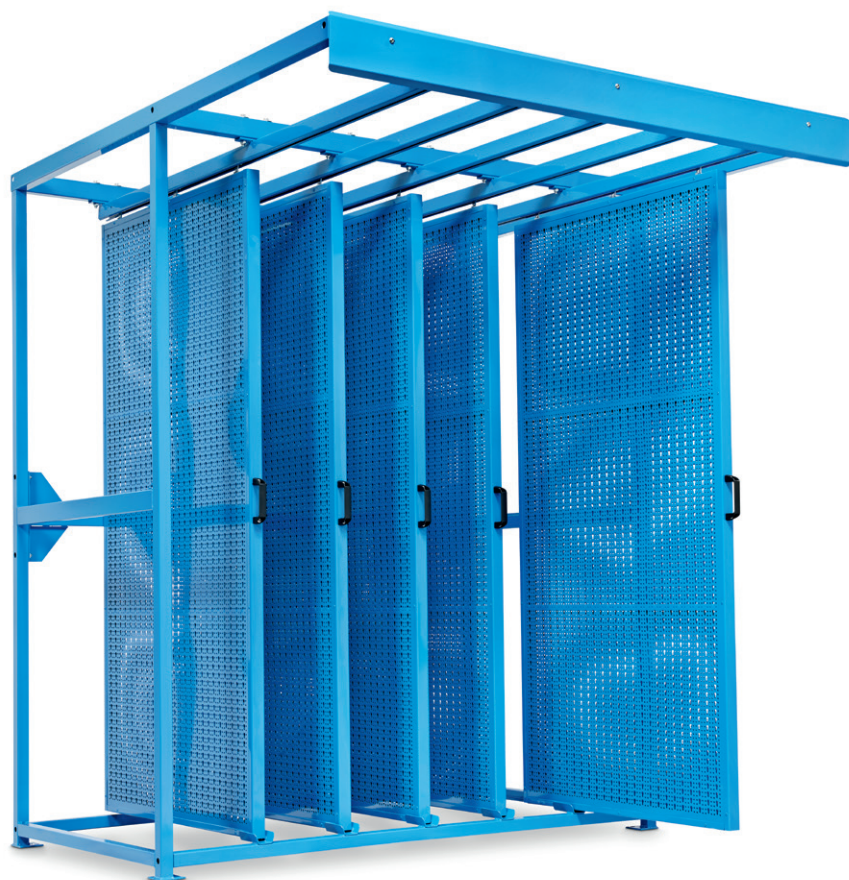

ART. C55

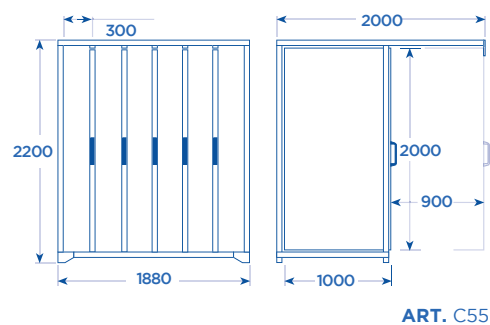
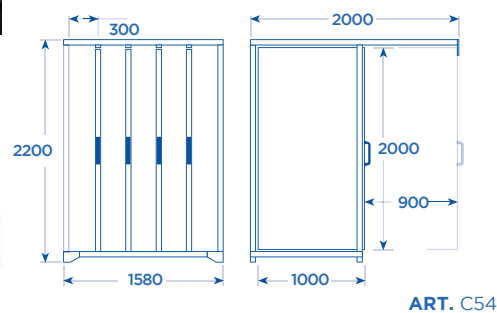
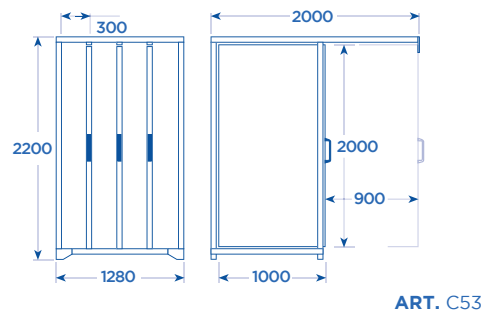

| ART. | m ² | Pannelli bifacciali Byfacial panels Panneaux double face Doppelseitigen Werkzeug |
|------------|----------------|---|
| C53 | 12 | 3 |
| C54 | 16 | 4 |
| C55 | 20 | 5 |

ACCESSORI

ACCESSORIES
 ACCESSOIRES
 ZUBEHÖR

GANCI

Hooks • Crochets • Haken

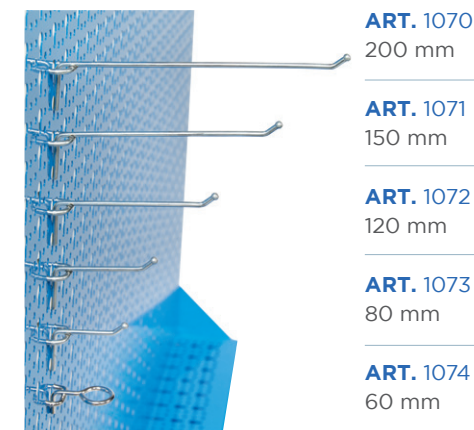

ART. 1075
 con occhiello
 with eyelet
 avec oeillet
 mit Öse

